

ZAKŁAD IZOLATORÓW ELEKTROTECHNICZNYCH
BOPLAST Sp. z o.o.

Adres:

ul. B.Krzywoustego 1,
tel. +48 59 862 01 86;
www.boplast.pl

84-300 Lębork
tel. 516 198 886
e-mail: boplast@boplast.pl

IZOLATORY WSPORCZE * IZOLATORY PRZEPUSTOWE * WYROBY IZOLACYJNE * USŁUGI

Post-bushing insulator 12 kV type IPW.RV.bp7-2/12/1,25

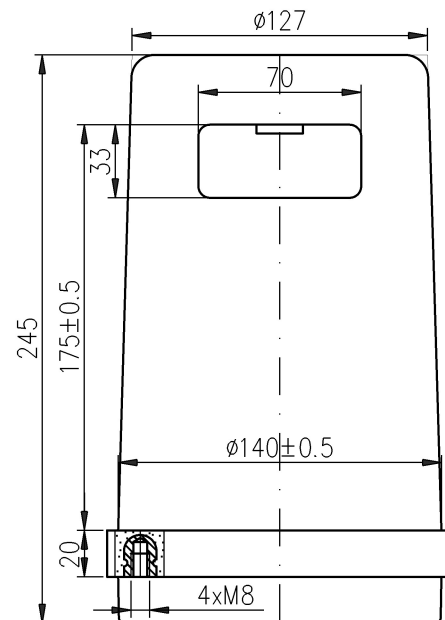
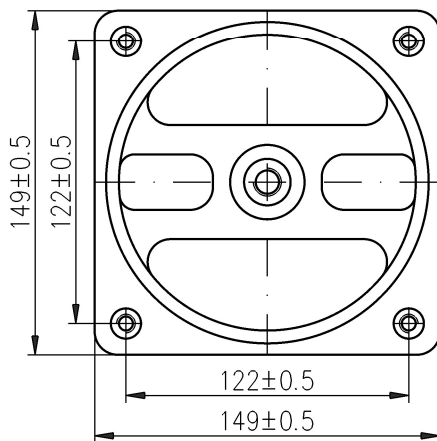
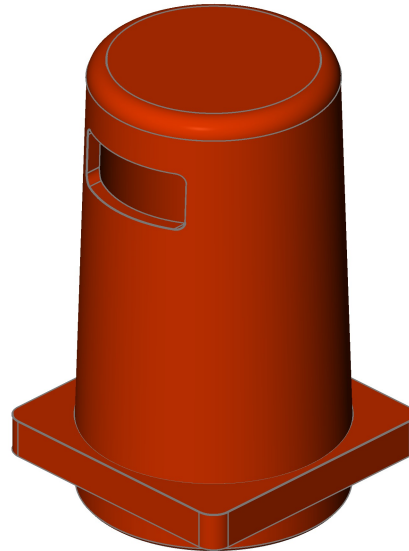
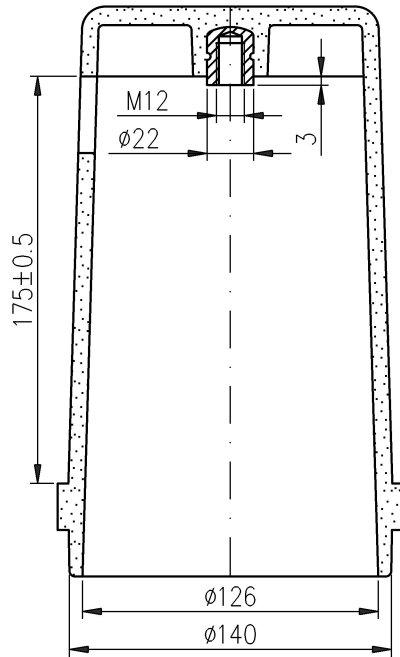

Rated insulation voltage	12 kV
Lighting impulse withstand voltage	75 kV
Dry withstand alternate voltage (50Hz, 1 min)	28 kV
Rated current	1250 A
Bending strength Po	2 kN
Weight	2,3 kg

1. Insulator material:
epoxy compound
2. Max screw tightening torque:
- M8 - 20 Nm
- M12 - 50 Nm
3. Voltage, temperature and short circuit requirements according to PN-EN 60137
4. Indoor insulator

1. Insulator is mounted to subsoil (wall, partition) using four M8 screws.

All data can be changed due to technological progress

DT BP.8.412.01 z dnia 08.07.2015

Order example:
Post-bushing insulator IPW.RV.bp7-2/12/1,25